

**Product Name: TWM101**  
**Art number: 402200**

**TECH LINK™**

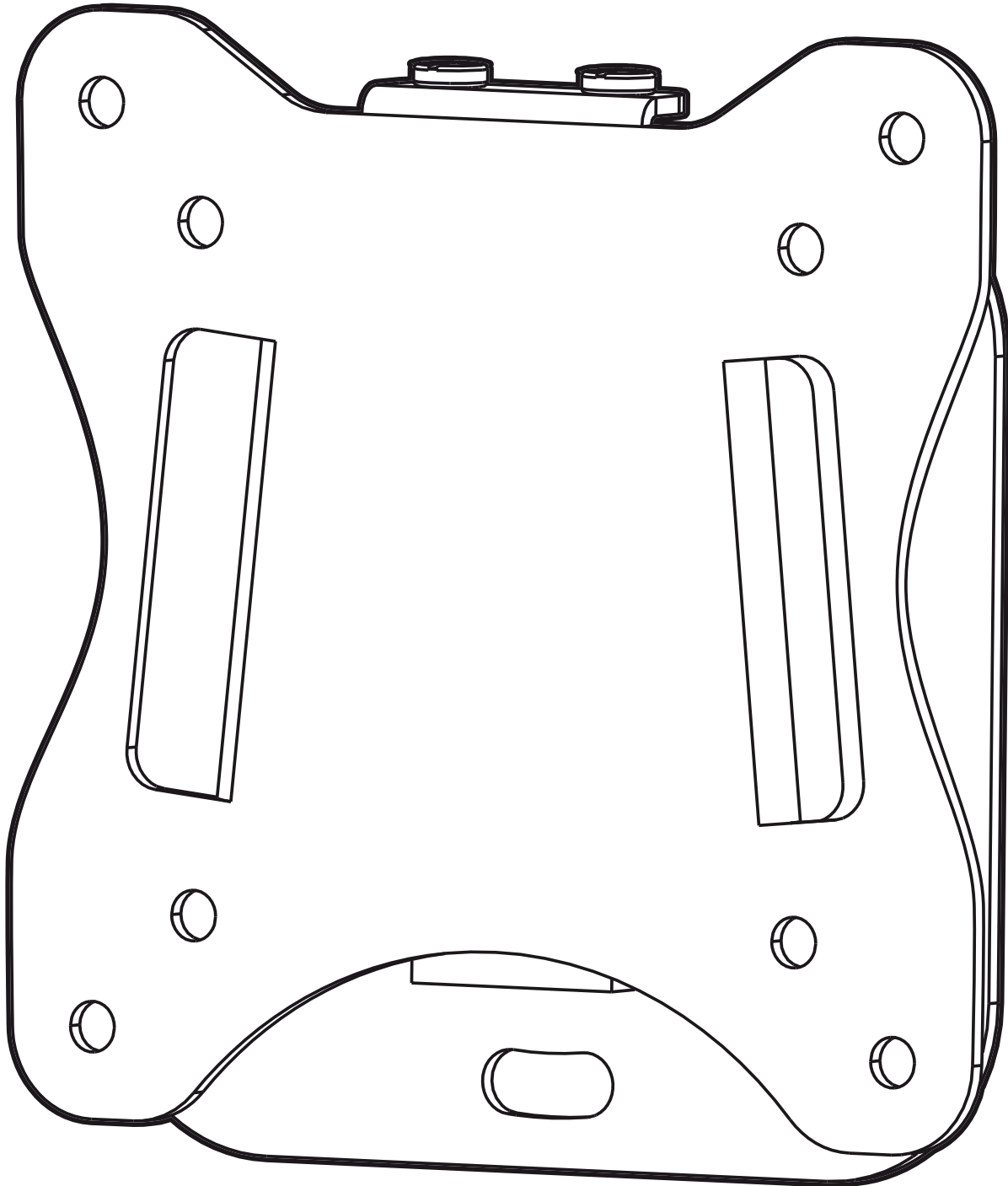

**TECHLINK , A Division Of Tapehand Ltd.**  
Units 7 and 8 Bat and Ball Enterprise Centre  
Bat and Ball Road  
Sevenoaks  
Kent  
United Kingdom  
TN14 5LJ



**0800 634 2699**

**spares@techlink.uk.com**

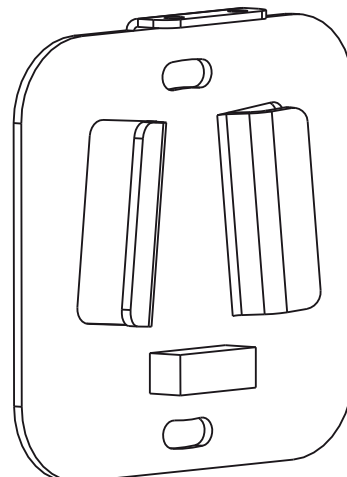
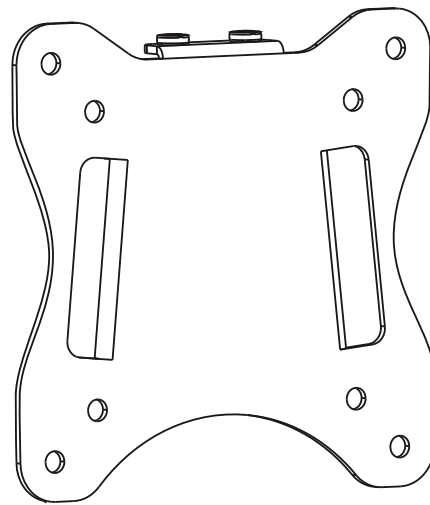
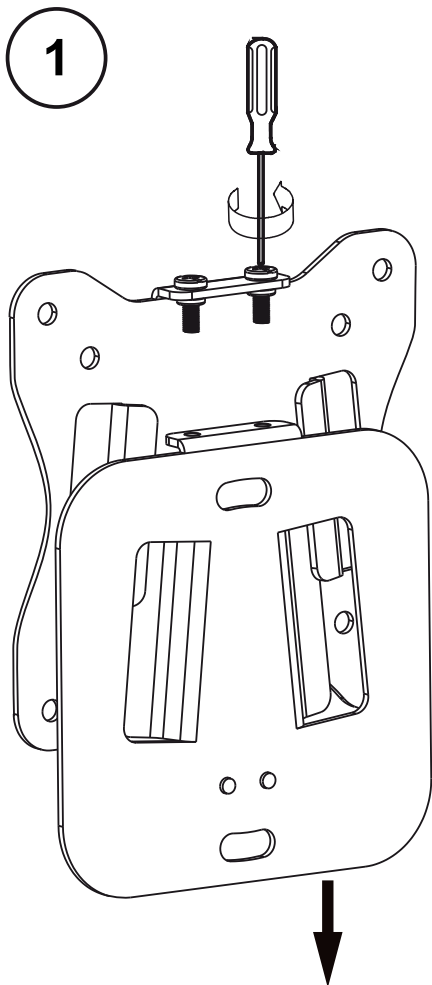
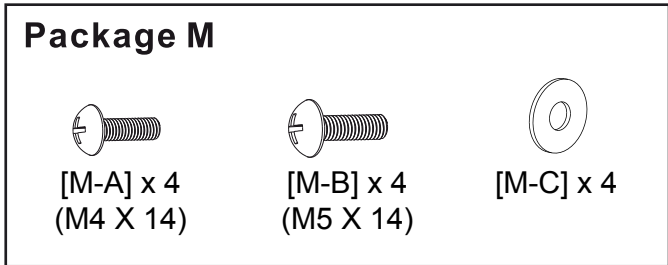
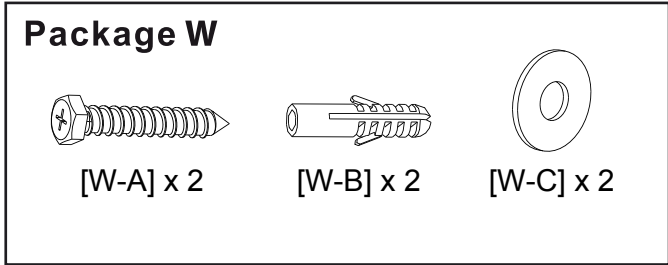
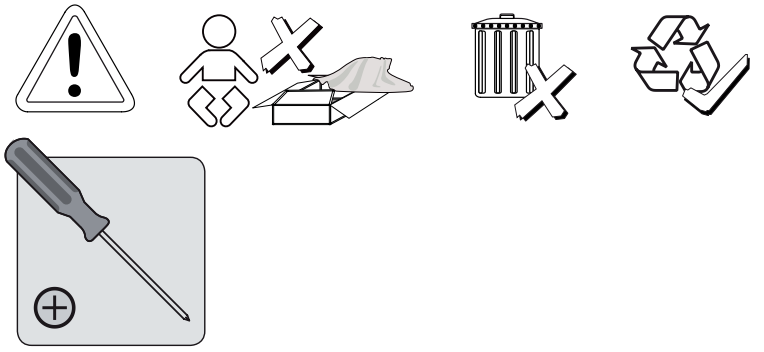
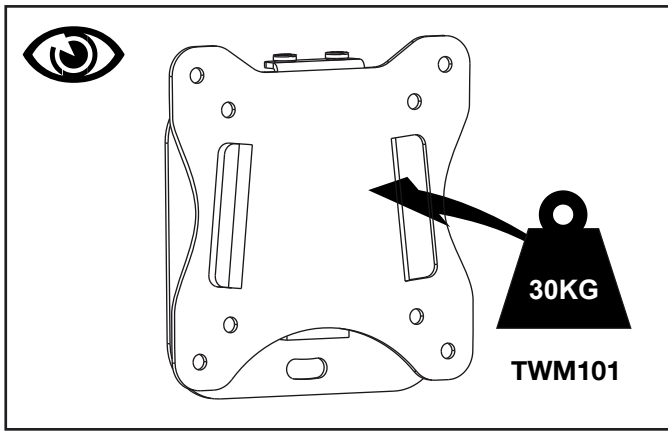

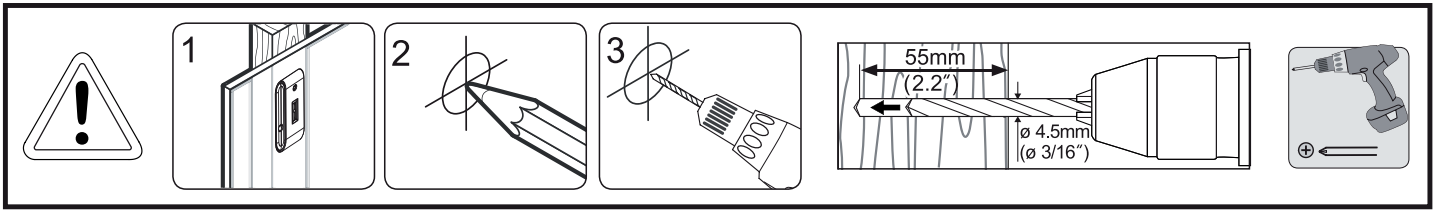



2a

W-A  x2

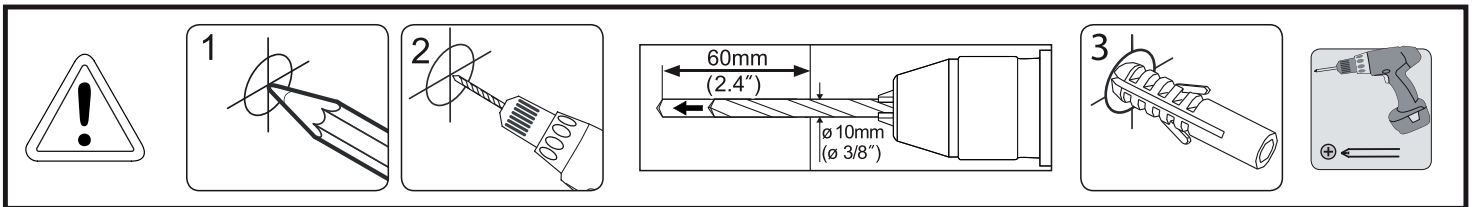
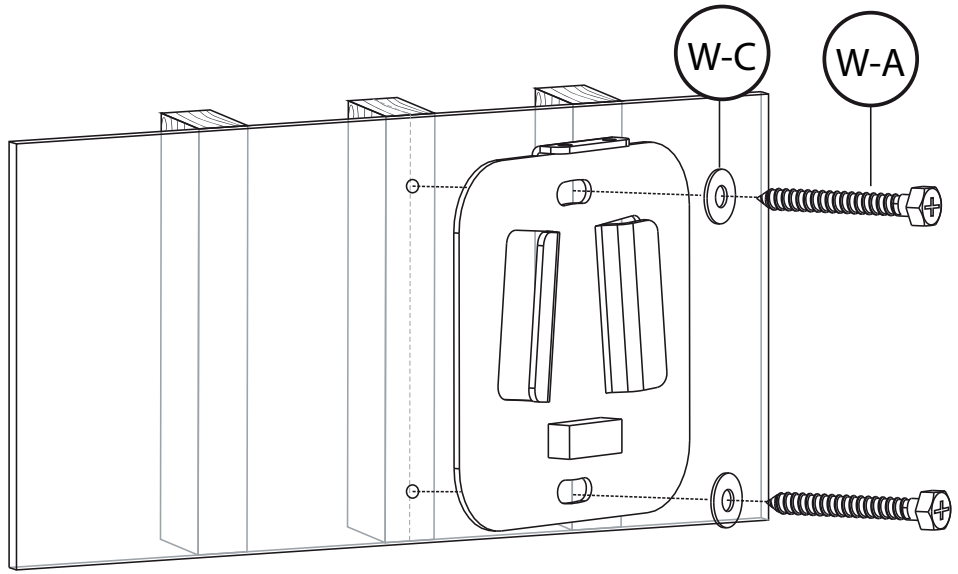
W-C  x2



2b

W-A  x2

W-B  x2

W-C  x2

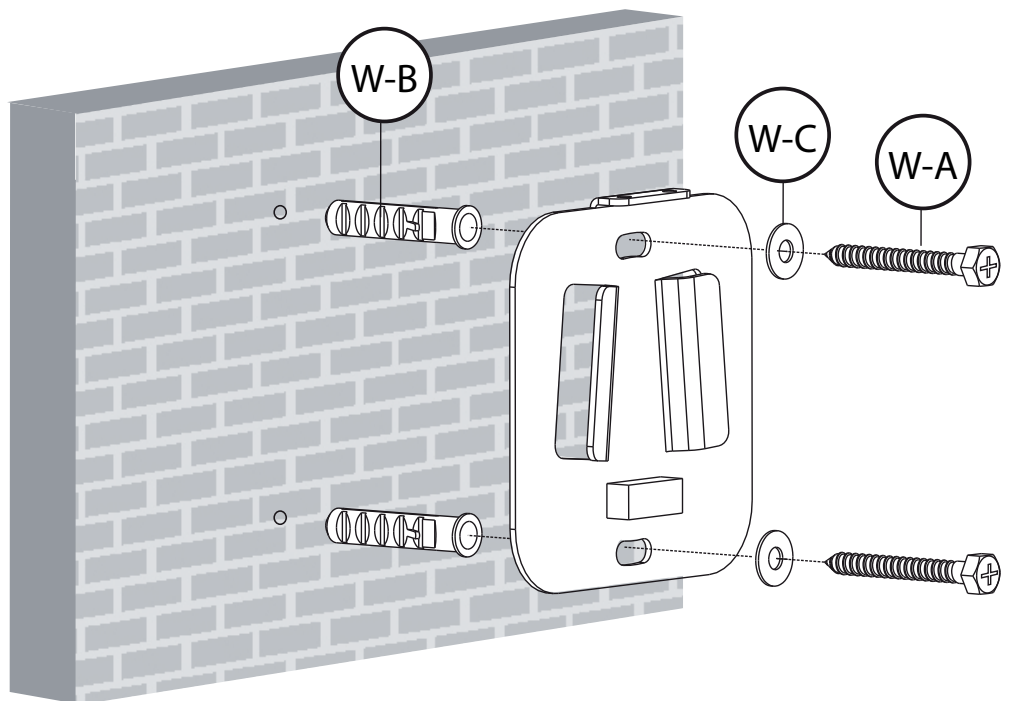

3

M-A x4

M-B x4

M-C x4

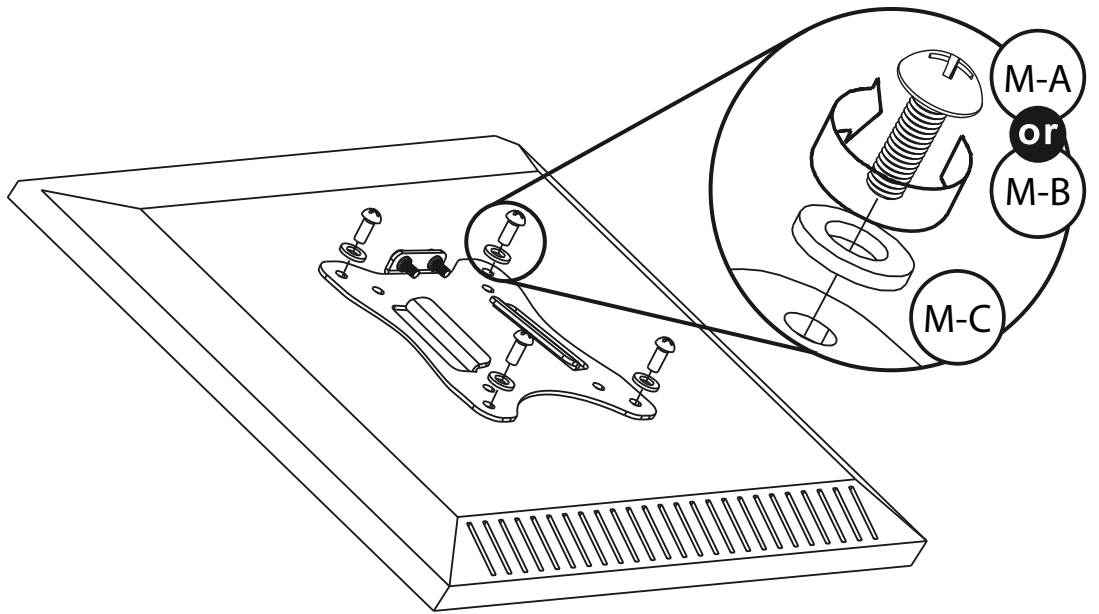

4

